

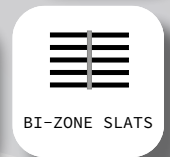

Length: 198 cm  
Width: 140 / 160 / 180 cm

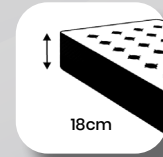

- A self-supporting revolving mechanism with a base frame allowing a knock-down upholstery to supply the action separately from the upholstered parts.
- Fixed back and seat cushions, no need to remove while opening the action.
- The luxury of a comfort bed with a 18 cm mattress either foam (depending of density) or spring.
- Strong interchangeable GOODSIDE® fibreglas slats.



# Nova H<sup>18</sup> Bi-Zone GOODSIDE®



Sedac - Belgium

Demo Video



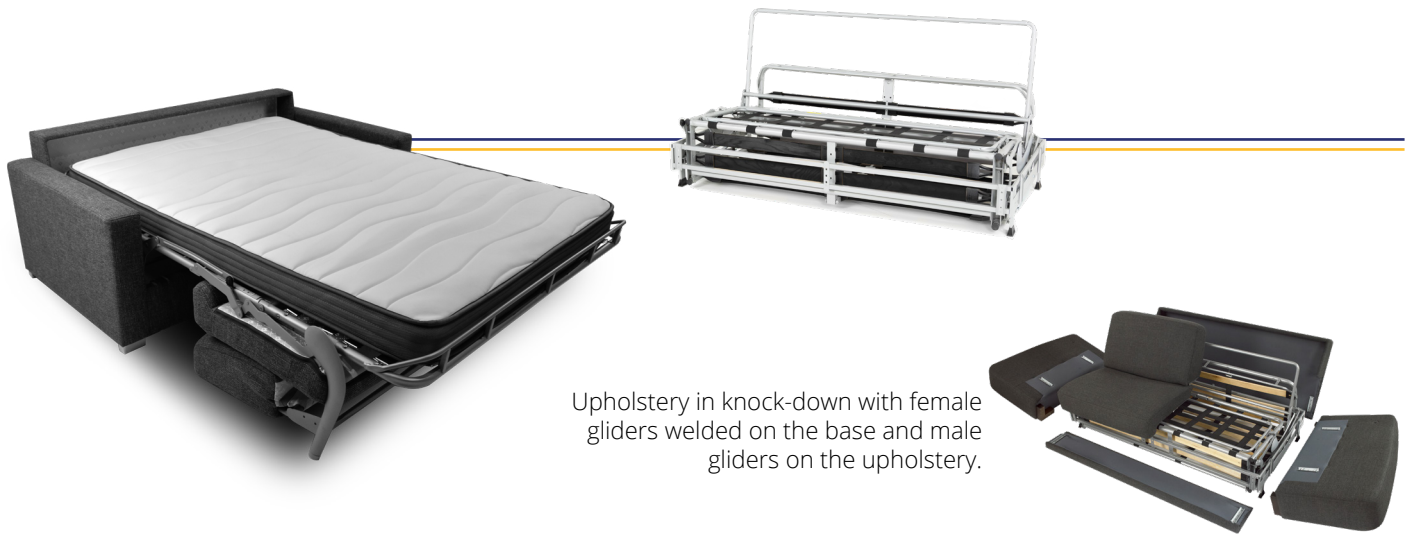

Upholstery in knock-down with female gliders welded on the base and male gliders on the upholstery.



Backrest with middle bar  
480 - 570 mm height



Backrest 390 mm height

### Accessories

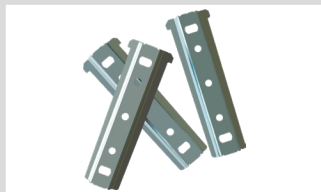

Male gliders



Link arm/back



Mattress strap

Ref	A	B mattress
202 / 180 cm	202 cm	180 cm
182 / 160 cm	182 cm	160 cm
162 / 140 cm	162 cm	140 cm

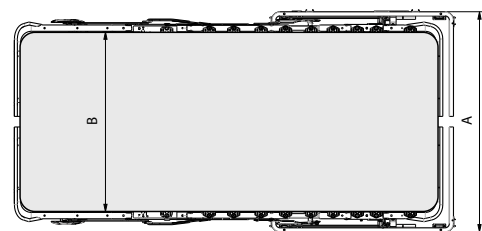
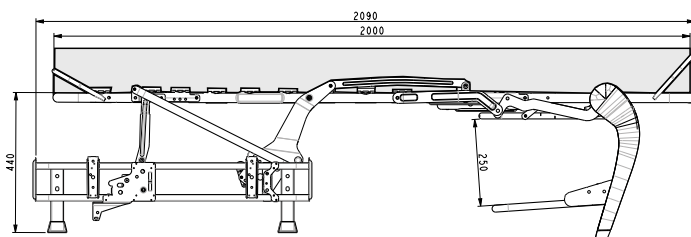
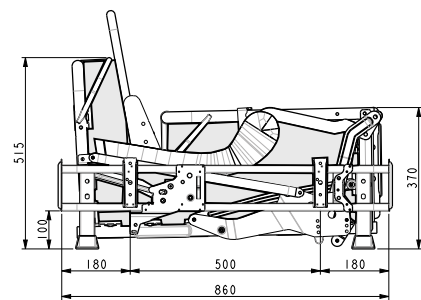

01/2024 We reserve the right to modify our products without prior advice. All pictures shown are for illustration purpose only. Actual product may vary.



sa SEDAC-MECOBEL nv • IZ Zuid Vlamingstraat 7 • 8560 Wevelgem, Belgium • t: +32 (0)56 41 28 81 • f: +32 (0)56 41 81 76  
 MERAL sa • B.P. 4 - 72800 Aubigné-Racan, France • t: +33 (0)2 43 46 21 22 • f: +33 (0)2 43 46 22 76  
 info@sedac-meral.com • www.sedac-meral.com